

FALCONSTOR

StorGuard™
with
StorSight™



MODERNIZING STORAGE FOR THE MULTI-CLOUD WORLD

FalconStor is modernizing block and backup storage for the hybrid, multi-cloud world. Our solutions are 100% software focused. Today over one Exabyte of data is under management using FalconStor products at over 1000 enterprise customers worldwide. Our technology partnerships ensure that our products are 100% compatible with what our customers are using today. A strong and growing number of enterprises and Managed Service Providers (MSPs) use StorGuard software, in combination with servers and storage purchased from any vendor, to provide enterprise-class data services across disk arrays, sites, and clouds.

STORGUARD ADDS ENTERPRISE-CLASS DATA SERVICES

Once StorGuard has been placed between the application servers and the disk arrays, several enterprise-class data services that would normally cost a lot, become available:

- Continuous Data Protection
- Data migration using either synchronous or asynchronous replication
- High Availability

Software is provided which can be run on the application servers to request that the mission-critical applications quiesce — by writing any data that is in RAM out two disks in preparation for an application-consistent snapshot of the volume.

Even without an agent being present on application servers, StorGuard can deliver continuous data protection. All I/O write activity is recorded, and when that bad day comes that a recovery is needed to a mission-critical server, the user interface of StorGuard allows the administrator to zoom in on the I/O activity graphically, to find a time where I/O activity was low. That is the smart way to select a recovery point in between when snapshots are not available.

StorGuard delivers high availability by standing in front of disk arrays that you own today or will purchase in the future. Nothing's more important than mission-critical applications having access to block storage resources. But disk arrays only offer high availability up to a point. With StorGuard, multiple disk arrays can be used to provide high availability to storage resources that can withstand the failure of an entire site.

CONTINUOUS REPLICATION ACROSS ARRAYS, SITES, AND CLOUDS

Move your data from point A to point B with StorGuard. An important part of moving to a new datacenter, MSP, or cloud is moving the data. In the stack you see the StorGuard servers placed between the application servers and the disk arrays.

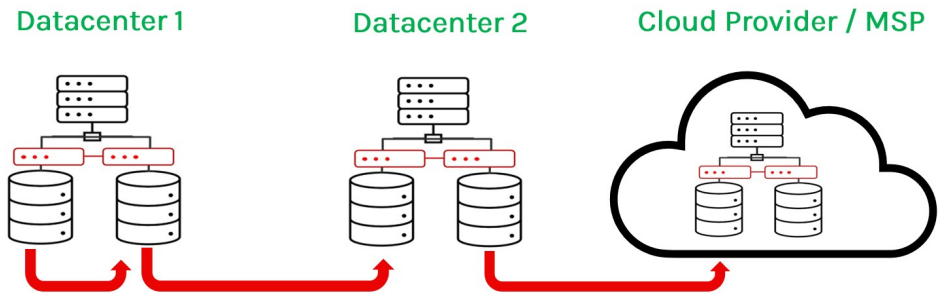

Using synchronous or asynchronous replication, data is written to the first disk array is transmitted to a second disk array located within the datacenter, at the MSP, or in a cloud. The distance between Point A and Point B impacts whether synchronous or asynchronous replication is used:

- When the distance is less than a metro-region, synchronous replication techniques can be used so the move will be non-disruptive to applications and application servers.
- When the distance is greater than a metro-region, asynchronous replication will be used and there will be a slight disruption that will be felt by applications and application servers when the cutover to the target side of the replication happens.

CONTINUOUS DATA PROTECTION

When disk arrays reside behind StorGuard servers, a continuous journal of all the blocks written is recorded with microsecond granularity. The stream of I/O writes can be suspended and resumed or can be tagged to note important points in time, such as when quiesced snapshots are taken of mission-critical servers.

Mission-critical Applications

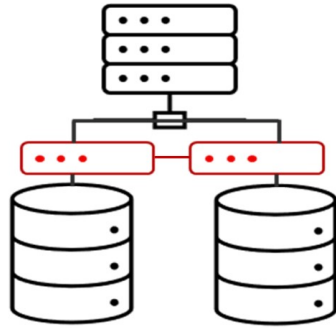

A GUI is provided to show the amount of IO activity over time. The administrator can zoom in on the timeline to choose a point of low IO activity as a recovery point. Because continuous data protection does not quiesce mission-critical servers, the recovery points are crash-consistent so when the mission-critical servers are rebooted, they will go into their own recovery mode for some period before they become available for use.

APPLICATION-CONSISTENT SNAPSHOTS

Beyond continuous data protection there is the ability to create application consistent snapshots for mission-critical servers such as Microsoft SQL server, Oracle, Sybase, DB2, Exchange, HANA, and most windows server applications that adhere to the VSS rules.

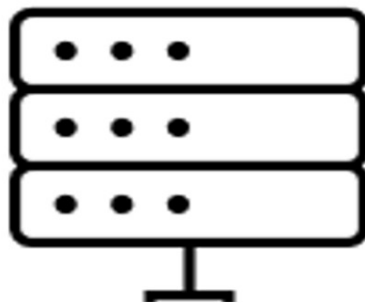

Application quiescing scripts and agents are provided by StorGuard and are run on mission-critical servers to force them to flush their contents in RAM to disk before the disk snapshot is taken. Snapshots can be taken on demand when requested by the administrator or backup application, or they can be performed on a schedule.

Up to 255 volumes can be simultaneously snapped if they are part of the consistency group. This ensures that all the volumes being used by mission-critical servers can be snapped and mounted to a single point in time.

Because the contents of RAM were flushed to disk when the application was quiesced, if the server is rebooted using the application consistent snapshot will not need to go through a recovery process, and therefore become available more quickly.

MANUAL RECOVERY

When an administrator needs to do a recovery of a mission-critical server they will choose either a quiesced snapshot or a point in time provided by the continuous data protection journal, which has granularity in microseconds. As mentioned previously, you can zoom choose the recovery point through the GUI.

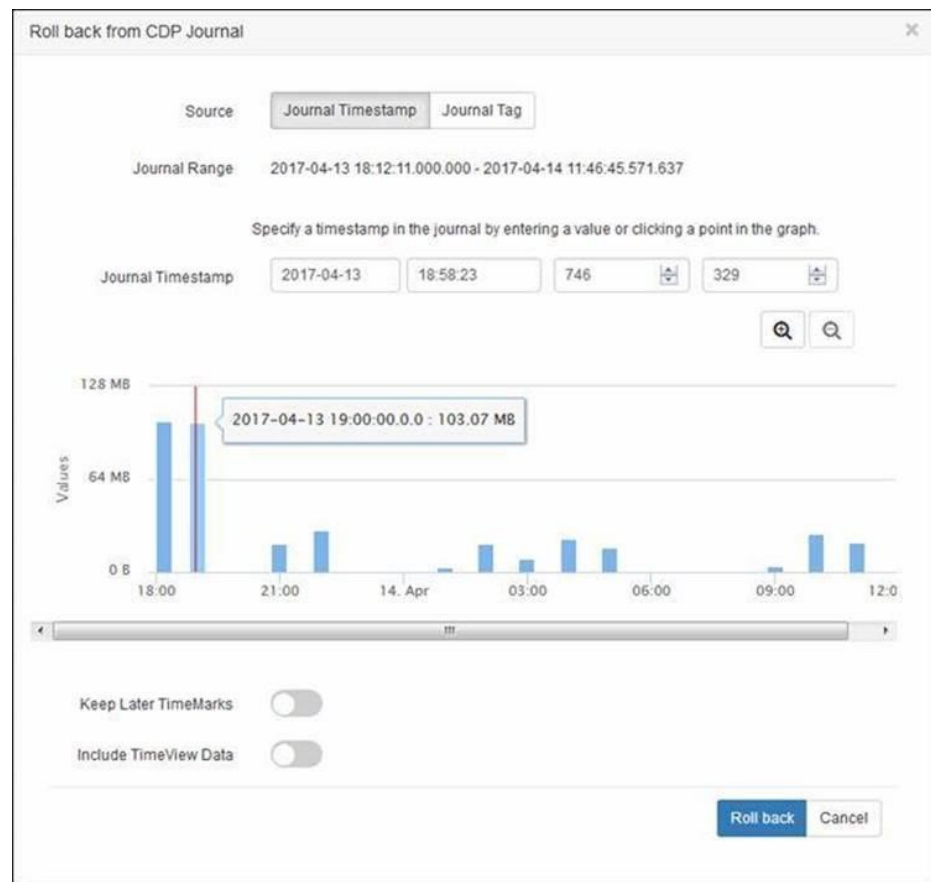

DISASTER RECOVERY (DR)

One of the purposes of capturing all the changes that are made to primary storage is to recover from a ransomware attack, by bringing the affected volumes back to a point in time prior to when the attack was launched.

For high availability, should the primary virtual disk fail, a failover to the virtual disk on the target side of the replication and a subsequent intelligent failback is provided by StorGuard. Depending on the customer's goals a second site, a remote MSP, or a public cloud can be used as the DR site.

StorGuard integrates with VMware vSphere and Microsoft Hyper-V at the recovery site. StorSight gives the ability to manage the recovery process for multiple host machines. And wizard-based mapping defines relationships between dependencies so that a smooth failover can be accomplished quickly and reliably.

Files, databases, systems, and entire sites of physical and virtual servers can be protected. MicroScan technology improves replication by eliminating blocks of data that have already been sent to the target side.

STORGUARD DISK MIRRORING

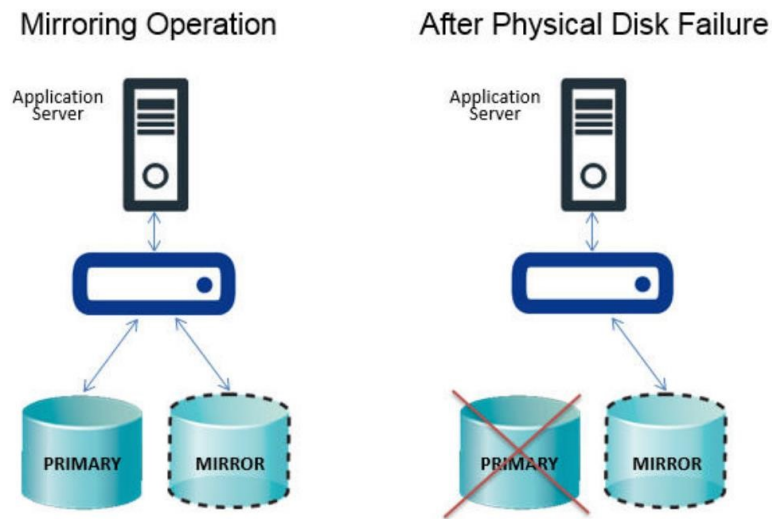

StorGuard disk mirroring is the simplest use case. It requires only a single industry standard server running the StorGuard Software in a data center. In this configuration all writes are sent to two virtual disks. Should the primary virtual disk fail, the mirror virtual disk becomes the primary.

STORGUARD HA

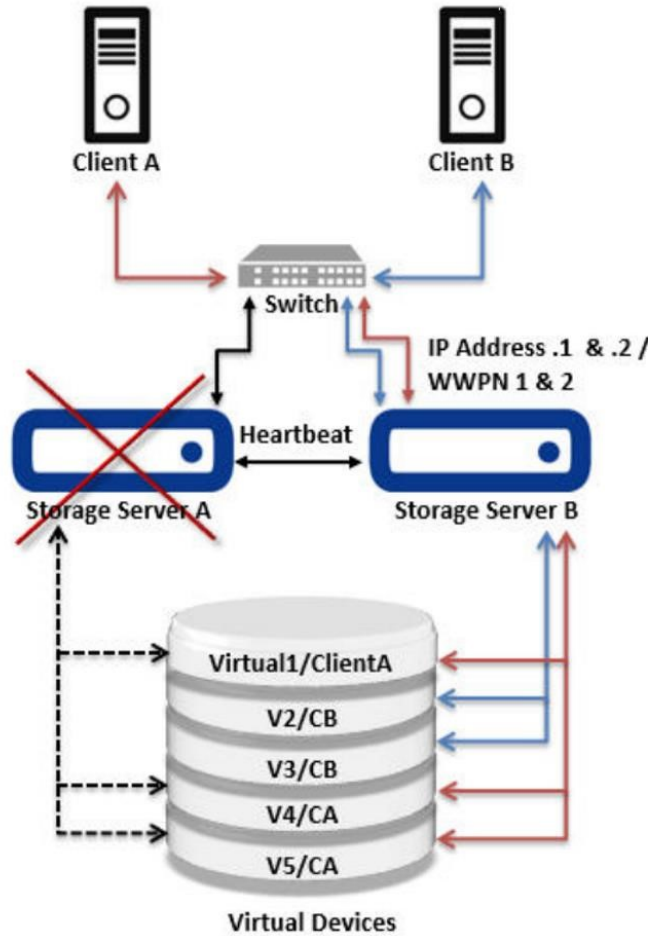

With two StorGuard servers are used in an active-active or active-passive configuration, the storage is protected and available even if a StorGuard server fails in the datacenter. Both the StorGuard servers communicate with each other using a heartbeat, and both StorGuard servers can see all disks.

Should a significant problem happen to one of the StorGuard servers, a failover will be triggered to the other StorGuard server that will take over all the volumes that were previously being managed by the failed StorGuard server, thus providing high availability.

STORGUARD HA - STRETCHED

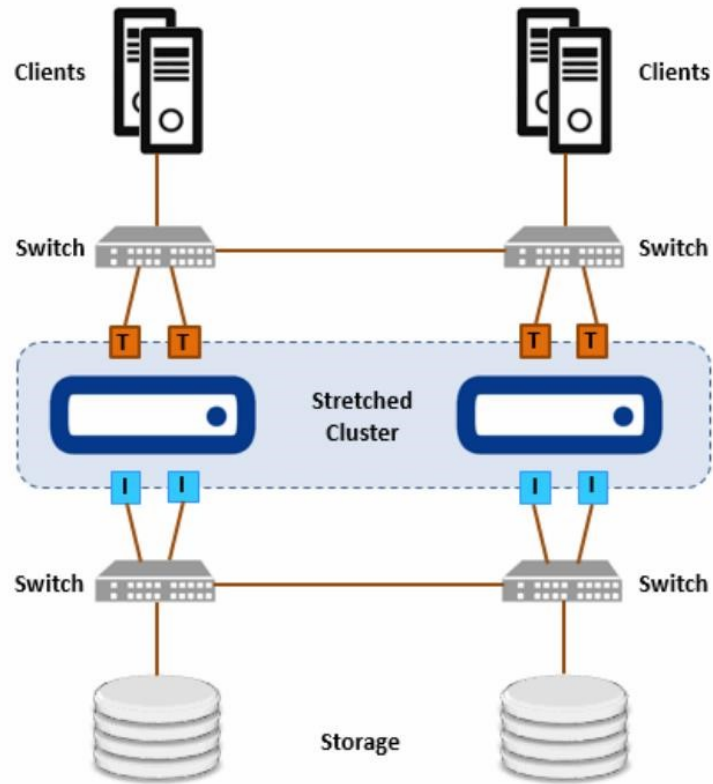

StorGuard HA Stretched is a configuration that does the same thing as StorGuard HA, but the distance between the two StorGuard servers can be larger, within a metro-region.

I/O CLUSTER

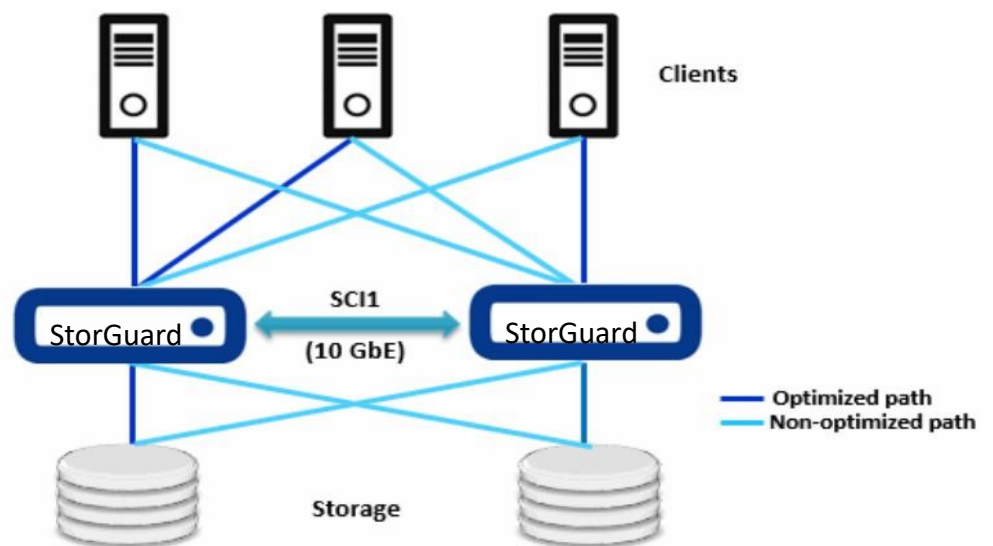

I/O Cluster configuration provides high availability for block storage. This requires two StorGuard servers that reside within one datacenter.

The StorGuard servers are active-active and talk with each other over a 10-gigabit link.

The StorGuard servers can see all disk arrays. Writes to one of the StorGuard servers are written to the underlying disk array and are mirrored to the second disk array. This is a never-fail architecture so there is not the concept of failing over and failing back between the StorGuard servers.

Services such as load balancing per virtual disk and I/O zoning for isolation are provided with performance of up to one million IOPS per I/O cluster. The “I/O Cluster” configuration protects against any failure in the storage path, the failure of the StorGuard server, or the failure of a virtual disk.

I/O MULTI-CLUSTER

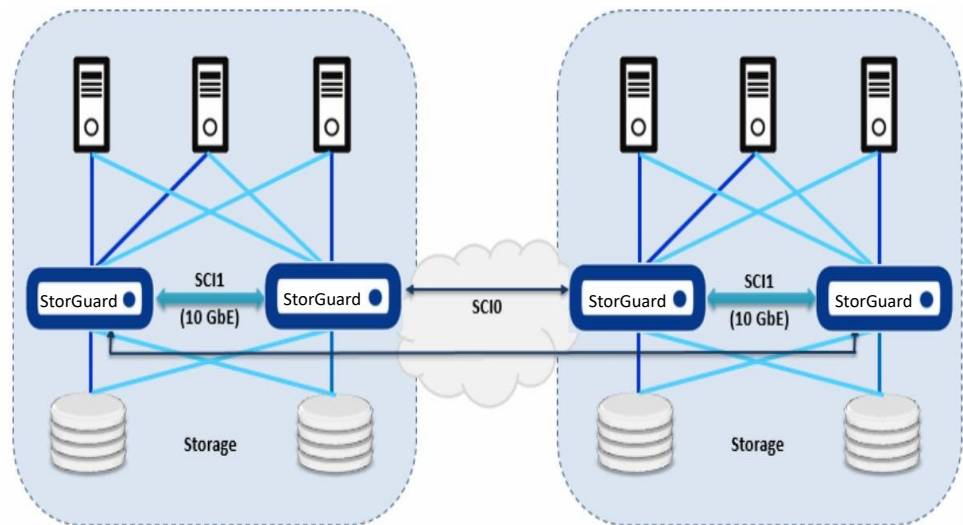

The I/O Multi-Cluster configuration uses two I/O clusters, which can be within a metro-region for added protection. Should one site fail, there is automatic failover/failback to the second site. This configuration requires four StorGuard servers.

ASYNCHRONOUS REPLICATION

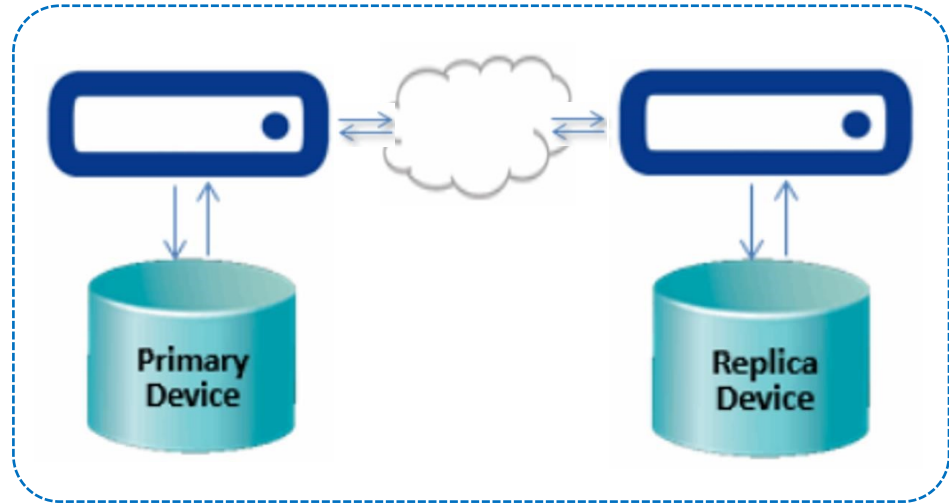

When distances are greater than a metro region, asynchronous replication is used. Writes to the primary StorGuard are transmitted to the replica MicroScan technology that looks inside individual disk sectors to efficiently find only the bits that have changed when replicating the block to the target side. The amount of network bandwidth being used can be throttled. The data being replicated remains fully compressed and encrypted for efficiency and safety. Cascaded replication is also possible from sites A to B to C. Once replication has been completed, the association between the two sites can be cut.

MANAGE ACROSS SITES AND CLOUDS WITH STORSIGHT™

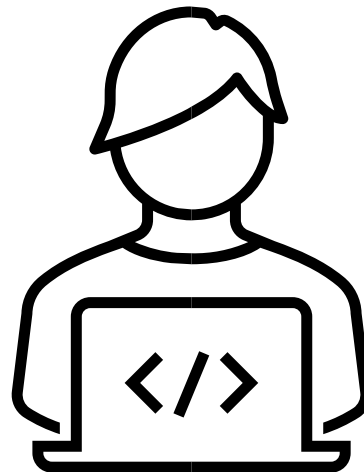

StorSight replaces FalconStor Management Console (Java GUI) with a powerful,

Web-based solution that manages all StorGuard and StorSafe VTL instances on physical or virtual machines. One StorSight server can manage any number of StorGuard and the StorSafe VTL servers across sites and clouds. Patches and any optional StorGuard agents can also be conveniently managed by StorSight.

Importantly, StorSafe VTL and StorGuard servers can be managed, even if they reside behind firewalls, without having to open any ports, because they periodically initiate communication with the StorSight server. This is an important safety feature because it avoids having to leave the firewall ports open across sites and clouds.

STORSIGHT USER EXPERIENCE & LICENSE MANAGEMENT

Through the StorSight management capability, customers get clear visibility about the status and health of backup operations worldwide. Predictive analytics give IT administrators enough time to avert problems that might otherwise occur in the future.

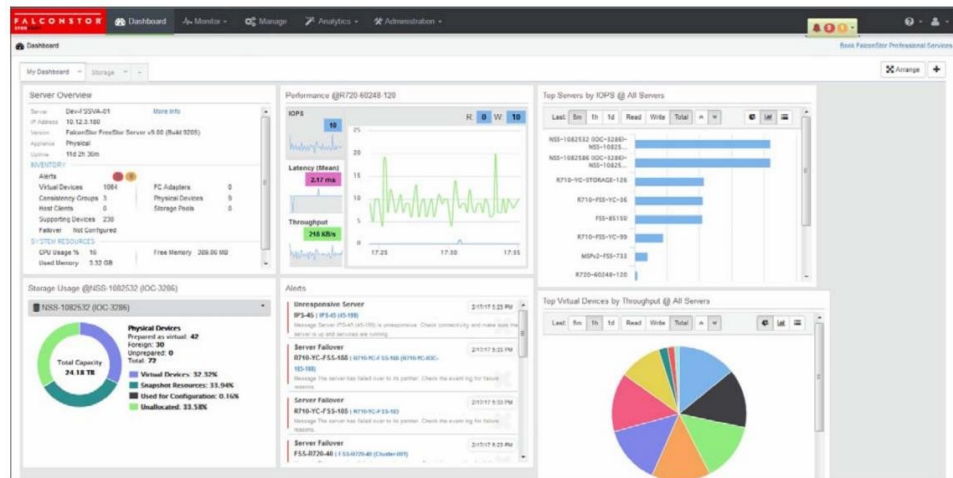

Licensing is based on the total capacity that customers need FalconStor to manage, which determines the monthly subscription price. Licenses are not tied to individual servers. Any number of instances of StorSight, StorSafe VTL, and StorGuard can be run at any number of locations, using a portion of the total capacity that is licensed.

Flexible licensing, based on one total capacity number, makes it easier for customers to use FalconStor software across their organization. Like any subscription software, all future software updates are included, as is worldwide support.

STORSIGHT ANALYTICS

StorSight includes analytics which are presented on the dashboard to allow administrators to monitor and manage the environment easily. Information about the current status of servers running the FalconStor software, historical trends in terms of resource usage, alerts, health indicators, and insight into which servers are using the most resources are available in real-time as they are updated every 10 seconds. A variety of widgets can be added, moved, and configured to make the dashboard ideal for each administrator.

STORSIGHT PREDICTIVE ANALYTICS

StorSight watches resource usage over time and uses that data to predict storage needs into the future. This gives administrators time to provide StorGuard and StorSafe VTL servers more capacity as needs grow over time.

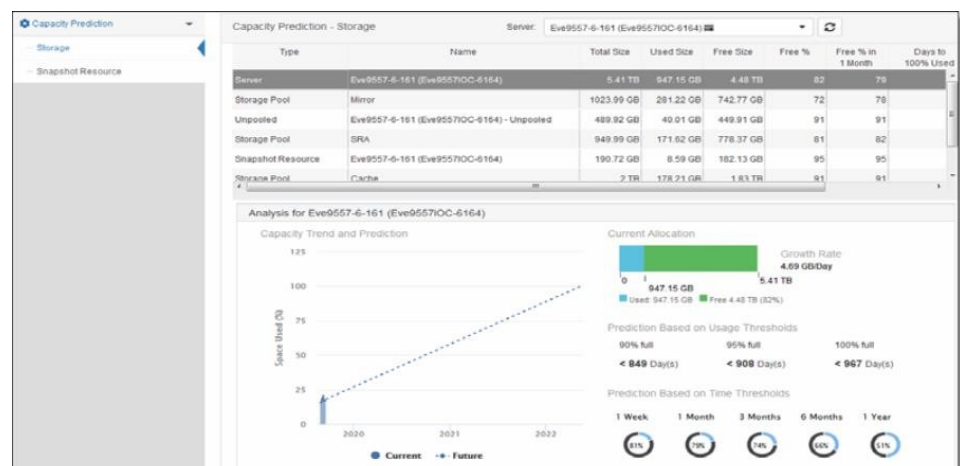

STORSIGHT REPORTS

StorSight provides several useful reports to customers to keep them aware of the status and health of all the storage virtualization and replication services.

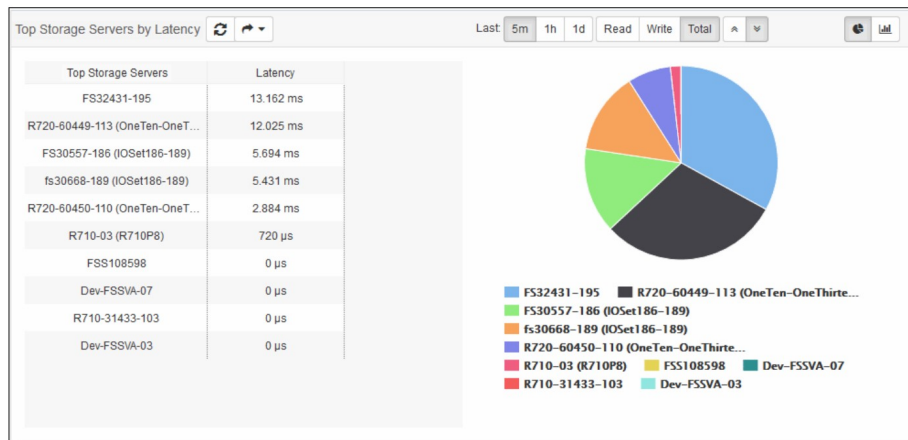

There are reports on inventories, capacity being used, performance, service status, the load being put up on each server, trend reports, and reports on the topic and components as well as custom trend reports that can be created on demand or sent out on a scheduled basis.

STORGUARD WITH STORSIGHT AVAILABILITY

StorGuard is a combination of the former FalconStor CDP and NSS products with additional features shown below.

CDP	StorGuard	
Y	Y	Scale-out as needs grow and get enterprise-class storage services
Y	Y	Move data from an old disk array to a new one, non-disruptively
Y	Y	Move data from one datacenter to another, or to the cloud
Y	Y	Performance, compatibility, and security patches
N	Y	StorSight - management across all sites and clouds through firewalls
N	Y	Total Capacity License - run any number of StorSafe and StorGuard
N	Y	StorSight - Multitenancy, RBAC, Billback, Dashboard, License Manager
N	Y	IO Cluster - Synchronous within datacenter with IO balancing & zoning
N	Y	IO Multi-Cluster - IO Clusters across a metro-region with failover/failback

StorGuard with StorSight is available today directly from FalconStor and its worldwide ecosystem of business partners.

Contact FalconStor: <https://www.falconstor.com/contact/>

Find a FalconStor reseller: <https://www.falconstor.com/partners/all/>